

V1B1114 V1B1134 V1B1115 V1B1135 V1B1116 V1B1136

Natural frequency : (1)
3 to 9 Hz



DESCRIPTION

This range of mounts has one or two steel mounting plates depending on the model, one or several high strength steel springs, 2 light alloy rings and a stainless steel wire cushion in each spring. All steel parts are painted.

APPLICATIONS

These very low frequency isolators (down to 3 Hz) can be used to mount machine rotating at speeds over 450 rpm, vibrators and impact machines, achieving an attenuation of about 95%.

They are all metal and can be used outdoors or in the harshest conditions.

As they do not creep, their life time may be the same as that of the machine they are used to mount.

A metal cushion inside each spring increases the damping factor and limits the amplification at the natural frequency.

(1) Natural frequencies with max/min loads, see : OPERATING CHARACTERISTICS.

DIMENSIONS

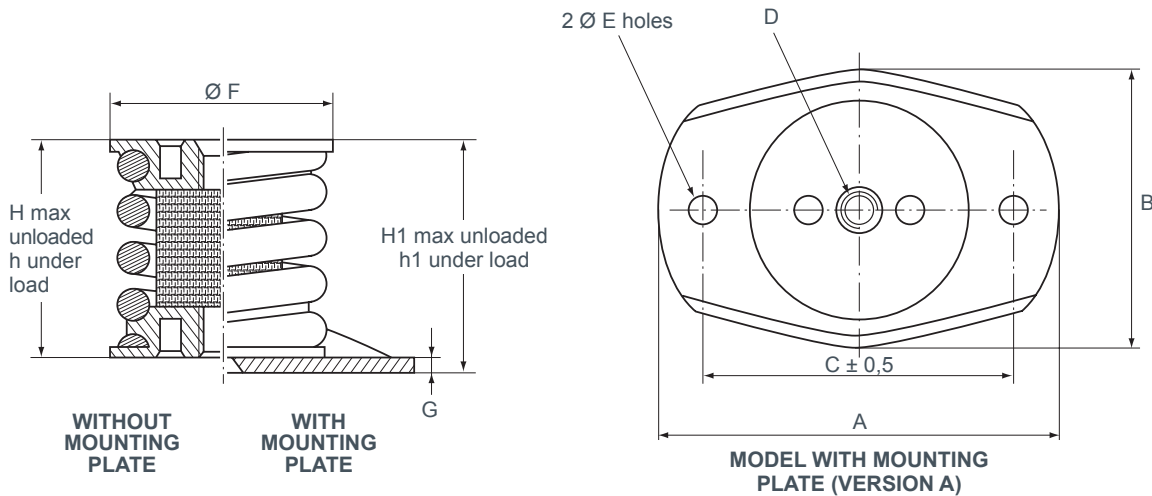

Reference	A (mm)	B (mm)	C (mm)	D	Ø E (mm)	Ø F (mm)	G (mm)	H (mm)	h (mm)	H1 (mm)	h1 (mm)	Tolerance / load (mm)
V1B1114	90	60	69,6	M8	7	47	2,5	59	47,5	61,5	50	±2
V1B1115	90	60	69,6	M8	7	47	2,5	59	47,5	61,5	50	±3
V1B1116	90	60	69,6	M8	7	47	2,5	88	68	90,5	70,5	±5
V1B1134	140	100	110	M12	11	78	4	88	78	92	82	±2
V1B1135	140	100	110	M12	11	78	4	88	78	92	82	±3
V1B1136	140	100	110	M12	11	78	4	142	120	146	124	±5

OPERATING CHARACTERISTICS

• **Vibrational and mechanical characteristics**

- Isolation of rotating machines with a minimum speed of :

Tr/mn	Series	Axial natural frequency = fz	Radial natural frequency = fr	Axial max. force	Radial max. force	Amplification factor at resonance
1 000	V1B1114 & V1B1134	7 to 9 Hz	fr = fz	4 g	1,2 g	≤ 5
650	V1B1115 & V1B1135	5 to 6 Hz	fr = fz	2 g	1,2 g	≤ 10
450	V1B1116 & V1B1136	3 to 4 Hz	fr = 0,7 fz	2 g	0,5 g	≤ 10

Maximum permitted excitation at natural frequency of suspension : ± 1 mm.

• **Load ranges**

Part number		Static load (daN)
without mounting plate	with mounting plate	
V1B1114-01	V1B1114-01A	6 to 10,5
V1B1114-02	V1B1114-02A	7,5 to 13,5
V1B1114-03	V1B1114-03A	12 to 20
V1B1114-04	V1B1114-04A	18 to 30
V1B1114-05	V1B1114-05A	24 to 46
V1B1114-06	V1B1114-06A	40 to 75
V1B1115-01	V1B1115-01A	5 to 7
V1B1115-02	V1B1115-02A	6 to 9
V1B1115-03	V1B1115-03A	9 to 14
V1B1115-04	V1B1115-04A	14 to 20
V1B1115-05	V1B1115-05A	20 to 30
V1B1115-06	V1B1115-06A	30 to 50
V1B1116-01	V1B1116-01A	5 to 7
V1B1116-02	V1B1116-02A	6 to 9
V1B1116-03	V1B1116-03A	9 to 14
V1B1116-04	V1B1116-04A	14 to 20
V1B1116-05	V1B1116-05A	20 to 30
V1B1116-06	V1B1116-06A	30 to 50

Reference		Static load (daN)
without mounting plate	with mounting plate	
V1B1134-01	V1B1134-01A	40 to 85
V1B1134-02	V1B1134-02A	65 to 125
V1B1134-03	V1B1134-03A	110 to 190
V1B1134-04	V1B1134-04A	175 to 270
V1B1134-05	V1B1134-05A	250 to 400
V1B1134-06	V1B1134-06A	360 to 560
V1B1134-07	V1B1134-07A	540 to 730
V1B1135-01	V1B1135-01A	30 to 48
V1B1135-02	V1B1135-02A	48 to 80
V1B1135-03	V1B1135-03A	80 to 130
V1B1135-04	V1B1135-04A	130 to 200
V1B1135-05	V1B1135-05A	200 to 310
V1B1135-06	V1B1135-06A	310 to 400
V1B1135-07	V1B1135-07A	420 to 560
V1B1136-01	V1B1136-01A	75 to 105
V1B1136-02	V1B1136-02A	95 to 130
V1B1136-03	V1B1136-03A	115 to 160
V1B1136-04	V1B1136-04A	160 to 230
V1B1136-05	V1B1136-05A	220 to 310
V1B1136-06	V1B1136-06A	300 to 415
V1B1136-07	V1B1136-07A	410 to 550

DIMENSIONS

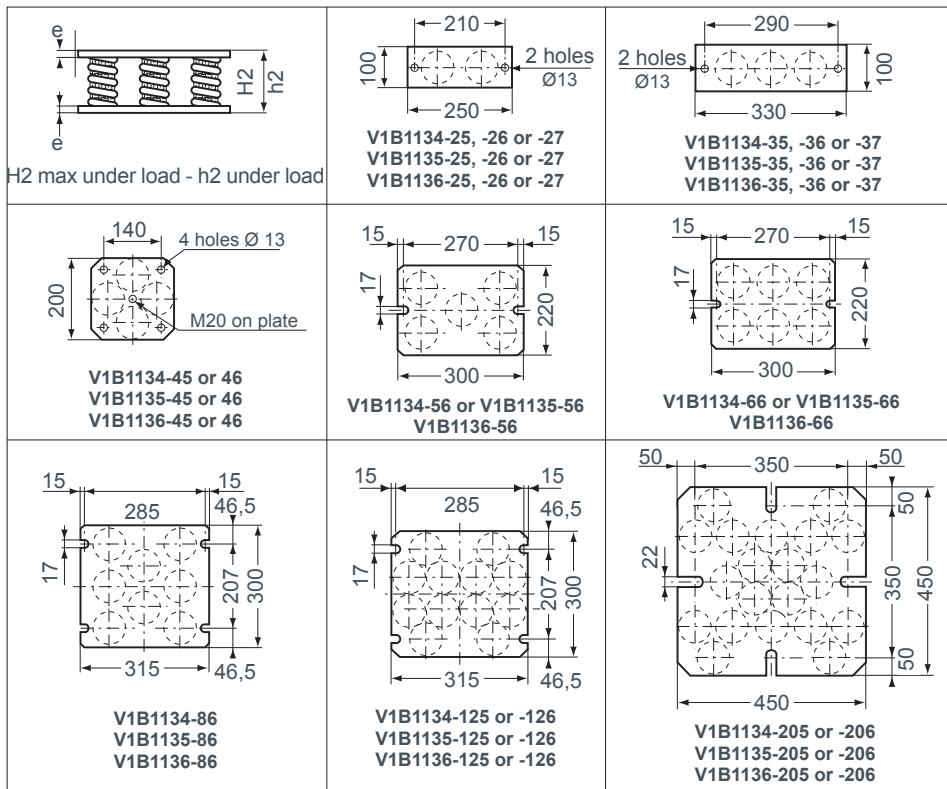

OPERATING CHARACTERISTICS

- Vibrational and mechanical characteristics (see single elements)
- Load ranges

Part number	Static load (daN)	H2 unload. (mm)	h2/s under load (mm)	e (mm)	Part number	Static load (daN)	H2 unload. (mm)	h2/s under load (mm)	e (mm)
V1B1134-25	500 to 800	96	86 ±3	4	V1B1135-66	1 860 to 2 520	108	98 ±3	10
V1B1134-26	720 to 1 120	96	86 ±3	4	V1B1135-67	2 520 to 3 360	110	98 ±3	10
V1B1134-27	1 080 to 1 460	106	94 ±3	8	V1B1135-86	2 480 to 3 360	108	98 ±3	10
V1B1134-36	1 080 to 1 680	106	94 ±3	8	V1B1135-87	3 360 to 4 480	110	98 ±3	10
V1B1134-37	1 620 to 2 190	106	94 ±3	8	V1B1135-125	2 340 to 3 720	108	98 ±3	10
V1B1134-45	1 000 to 1 600	104	94 ±3	8	V1B1135-126	3 720 to 5 040	108	98 ±3	10
V1B1134-46	1 440 to 2 240	104	94 ±3	8	V1B1135-127	5 040 to 6 720	110	98 ±3	10
V1B1134-47	2 160 to 2 920	106	94 ±3	8	V1B1135-205	3 900 to 6 200	108	98 ±3	10
V1B1134-56	1 800 to 2 800	108	98 ±3	10	V1B1135-206	6 200 to 8 400	108	98 ±3	10
V1B1134-57	2 700 to 3 650	110	98 ±3	10	V1B1135-207	8 400 to 11 200	110	98 ±3	10
V1B1134-66	2 160 to 3 360	108	98 ±3	10	V1B1136-25	440 to 620	148	128 ±5	4
V1B1134-67	3 240 to 4 380	110	98 ±3	10	V1B1136-26	600 to 830	148	128 ±5	4
V1B1134-86	2 880 to 4 480	108	98 ±3	10	V1B1136-27	820 to 1 100	158	136 ±5	8
V1B1134-87	4 320 to 5 840	110	98 ±3	10	V1B1136-36	900 to 1 260	158	136 ±5	8
V1B1134-125	3 000 to 4 800	108	98 ±3	10	V1B1136-37	1 230 to 1 650	158	136 ±5	8
V1B1134-126	4 300 to 6 720	108	98 ±3	10	V1B1136-45	880 to 1 280	156	136 ±5	8
V1B1134-127	6 480 to 8 760	110	98 ±3	10	V1B1136-46	1 200 to 1 660	156	136 ±5	8
V1B1134-205	5 000 to 8 000	108	98 ±3	10	V1B1136-47	1 640 to 2 200	158	136 ±5	8
V1B1134-206	7 200 to 11 200	108	98 ±3	10	V1B1136-56	1 500 to 2 075	160	140 ±5	10
V1B1134-207	10 800 to 14 600	110	98 ±3	10	V1B1136-57	2 050 to 2 750	162	140 ±5	10
V1B1135-25	390 to 620	96	86 ±3	4	V1B1136-66	1 800 to 2 490	160	140 ±5	10
V1B1135-26	620 to 840	96	86 ±3	4	V1B1136-67	2 460 to 3 300	162	140 ±5	10
V1B1135-27	840 to 1 120	106	94 ±3	8	V1B1136-86	2 400 to 3 320	160	140 ±5	10
V1B1135-36	930 to 1 260	106	94 ±3	8	V1B1136-87	3 280 to 4 400	162	140 ±5	10
V1B1135-37	1 260 to 1 680	106	94 ±3	8	V1B1136-125	2 640 to 3 720	160	140 ±5	10
V1B1135-45	780 to 1 240	104	94 ±3	8	V1B1136-126	3 600 to 4 980	160	140 ±5	10
V1B1135-46	1 240 to 1 680	104	94 ±3	8	V1B1136-127	4 920 to 6 600	162	140 ±5	10
V1B1135-47	1 680 to 2 240	106	94 ±3	8	V1B1136-205	4 400 to 6 200	160	140 ±5	10
V1B1135-56	1 550 to 2 100	108	98 ±3	10	V1B1136-206	6 000 to 8 300	160	140 ±5	10
V1B1135-57	2 100 to 2 800	110	98 ±3	10	V1B1136-207	8 200 to 11 000	162	140 ±5	10